



Bond | Wall Lamp

Light is harbored by the Bloom Wall Lamp much like a flower's core is kept by its leaves. Its layered composition originates a soothing continuity effect between the direction of the light and the shape of the metal lampshades.

AS PICTURED

MATERIALS & FINISHES

Front lampshade: Brushed Hammered Brass.
Back lampshade: Antique Brass.

DIMENSIONS

W: 30 cm | 11,8"
 D: 18 cm | 7,1"
 H: 64 cm | 25,2"

BULBS & VOLTAGE

2 x E27 LED Dimmable, 4W 2700K 470lm | 230V
EU & UK - Bulbs, sockets and plugs included;
USA - Wiring, bulbs, sockets and plugs not included;
Non-EU requirements - Please send an email to info@gingerandjagger.com

LIGHT SWITCH

Standard switch.
 Also available dimmable switch and DALI controller system.

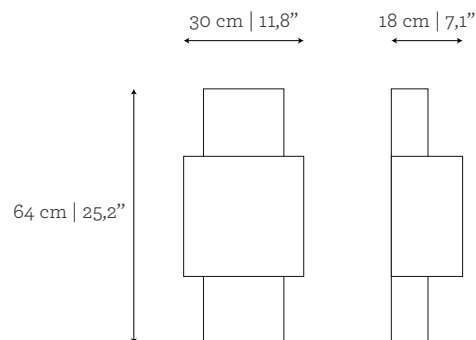

CUSTOM/BESPOKE

This product is suitable for custom size. Range between:
 W: 25 cm | 9,8" - 60 cm | 23,6"
 D: 18 cm | 7,1" - 25 cm | 9,8"
 H: 45 cm | 17,7" - 100 cm | 39,4"

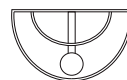

ENVIRONMENT

This product is made for living areas in interior spaces only. This product is not specified for bathrooms, spa's or humid environments. Not suitable for exteriors.

VOLUME

0,03 m³ | 1,06 ft³

WEIGHT

3 kg | 6,6 lbs

Packed (in reinforced carton case)

0,09 m³ | 3,18 ft³

6 kg | 13,2 lbs

GINGER & JAGGER

PRODUCT OPTIONS





Bond | Wall Lamp

MATERIALS & FINISHES

Front lampshade: Brass, Nickel or Copper plate in polished or brushed Hammered finishing.

Back lampshade: Brass, Nickel or Copper plate in polished, brushed or antique finishing.

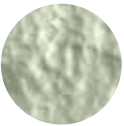
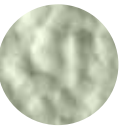
Front lampshade:

					
HAMMERED BRASS Polished	HAMMERED BRASS Brushed	HAMMERED NICKEL Polished	HAMMERED NICKEL Brushed	HAMMERED COPPER Polished	HAMMERED COPPER Brushed

Back lampshade:

					
BRASS Polished	BRASS Brushed	BRASS Antique	NICKEL Polished	NICKEL Brushed	NICKEL Antique
					
COPPER Polished	COPPER Brushed	COPPER Antique			

LIGHT DIRECTION

